

ECON D3

Sauna control unit

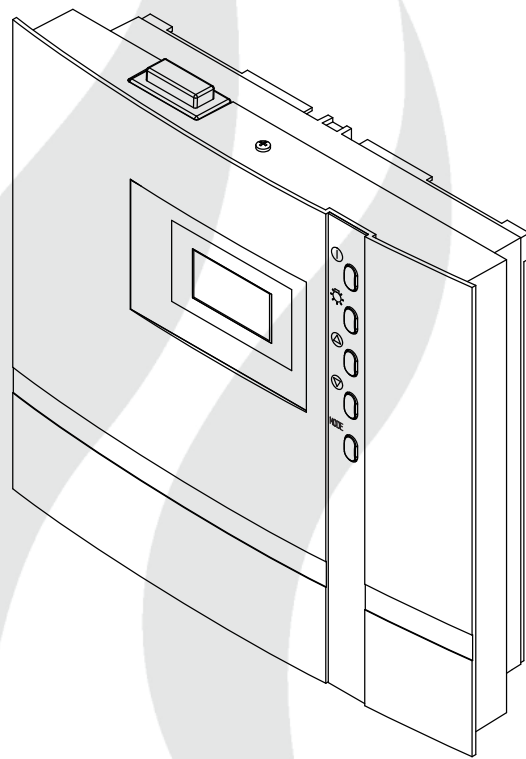

GB Installation and operating instruction

Made in Germany

CE IP x4



English

Table of Contents

Scope of delivery	4
Technical specifications	4
General information about sauna bathing	5
General safety precautions	6
Mechanical installation of the control unit	
Installation place	8
Surface-mounting installation	8
Semi-recessed installation	9
Connecting the temperature sensor cables	10
Installation and connection of the temperature sensor	10
Installation and connection of the second sensor (bench sensor)	11
Electrical connections.....	13
Connecting the sauna heater	13
Connecting a power extension unit (LSG)	13
Connecting the sauna lamp.....	13
Installation diagram	14
Terminal layout on the circuit board.....	14
Connection of sauna heaters up to 9 kW	15
Connection of sauna heaters over 9 kW	15
Operation	16
General.....	16
Location of operation elements	16
Operating buttons.....	16
Interface in stand-by	17
Interface in active operation.....	17
Interface in energy-saving mode	17
Cabin lighting.....	18
Initial commissioning	19
Change language.....	20
Time setting	20
Activate the Life - Guard.....	21
Activate / deactivate the child lock	21
Switching on the sauna heater	22
Switching off the sauna heater	22
Switching on the sauna heater with Life - Guard	22
Individual settings	23

Cabin temperature	24
Life - Guard	24
Auto-Stop (heating time limitation).....	25
Preselection time (pre-set timer).....	27
Activate the preselection time	28
Deactivate the preselection time	28
Extend the time setting for sauna time.....	29
Unit fuses.....	29
Error messages and troubleshooting.....	30
The device switch (Switch-off)	31
Service Address:.....	32
Guarantee	32
General Terms and Conditions of Service.....	33

Scope of delivery

(changes without prior notice reserved)

The package contents includes:

Control unit

1. Temperature sensor, consisting of: sensor board with overheating protection fuse, KTY-sensor, sensor housing, two 3x25 mm fastening screws and 2,0 m long sensor cable.
2. Plastic bag with three 4 x 20 mm fastening screws.
3. 1 replacement overheating protection fuse (inside control unit housing)
4. Installation and operating manual

Technical specifications

Rated voltage:	400 V 3 N 50 Hz AC
Power output:	max. 9 kW resistive load (AC1 - operation).
Power extension:	up to 36 kW possible with an optional LSG device.
Heating time limitation:	6 h, 12 h, without limitation (via jumper setting)
Display:	LCD Display 65 x 37 mm, alphanumeric, with backlighting
Dimensions (H x W x D):	220 x 250 x 67 mm
Protection class:	IPx4 as per EN 60529 splash proof
Temperature control range:	30 - 115°C
Temperature sensor system:	KTY-sensor with safety overheating limiter fuse 142°C
Control characteristics:	Digital two-point control
Output for cabin lighting:	max. 100 W
Ambient temperatures:	-10°C to +40°C
Storage temperatures:	-20°C to +70°C

Dear customer

You have purchased a high-quality technical device with which you will have years of sauna fun. This sauna control unit was designed and inspected according to the current European safety standards and manufactured at the factory in accordance with the quality management standard DIN EN ISO 9001:2000.

This detailed installation and operation manual has been prepared for your information. Please observe in particular the **important notes** and the information on electrical connection.

We wish you exhilarating recreational experience and lots of fun with your sauna!

Intended use

This sauna control unit is exclusively intended for the control of the sauna heater in a sauna cabin.

Any other use over and above the intended purpose is not considered as appropriate use! Compliance of the standard operation, maintenance and repair conditions is also an element of appropriate use.

The manufacturer cannot be held liable for deviating, unauthorized alterations and any resulting damages: the initiator of these changes bears the full risk.

General information

Please check whether the unit has arrived in perfect condition. Any transport damages should be immediately reported to the freight forwarder delivering the goods or you should contact the company that shipped the goods.

Please note that you will only be able to achieve an optimum sauna climate if the cabin with its air intake and ventilation, the sauna heater and the control unit are aligned to each other.



Please observe the information and stipulations made by your sauna supplier.

Sauna heaters heat up your sauna cabin using heated convective air. Here, fresh air is drawn in from the air intake which, when heated, rises upwards (convection) and is then circulated within the cabin. Part of the used air is pushed out through the vent in the cabin. This creates a typical sauna climate which can achieve temperatures of approx. 110°C measured directly under the ceiling of your sauna, dropping in temperature to approx. 30-40°C towards the floor. It is therefore not unusual to measure temperatures of 110°C on the temperature sensor hanging over the heater, whilst the thermometer hanging on the sauna wall, approx. 20-25 cm under the cabin ceiling, only indicates 85°C. The bathing temperature generally lies between 80°C and 90°C in the area of the upper bench when the temperature is set to maximum.

Please note that the highest temperatures are always generated over the sauna heater and that the temperature sensor and the safety limiter must be mounted there in accordance with the control unit installation instructions.

When heating up for the first time, you may notice a slight smell caused by evaporating lubricants used in production processes. Please ventilate your cabin before beginning your sauna bath.

General safety precautions

- This device can be used by children aged 8 upwards and by persons with physical, sensory, or mental disabilities, or who have inadequate experience and knowledge if they are supervised or if they have received adequate instruction in how to use the device safely and understand the associated risks. Children may not play with this device. Children may not clean or carry out any user maintenance if unsupervised.
- Children are to be supervised in order to make sure that they do not play with this device.
-  **Attention:** It is forbidden to install the control box in a closed switch cabinet or behind a wooden panelling!
- The electrical installation may be done only by a qualified electrical technician.
- You must comply with the regulations of your power supply company and applicable VDE regulations (DIN VDE 0100).
-  **WARNING:** Never attempt repairs or installations yourself, as this could result in serious injury or death. Only a qualified technician may remove the housing cover.
- Please note the dimensions in the assembly instructions, especially when installing the temperature sensor. The temperature above the oven is critical for the temperature setting. The temperature can be held within operating parameters and a minimal temperature gradient inside the bench area of the sauna cabin can be achieved only if unit is assembled correctly.
- The device may only be used as intended as a control unit for sauna ovens up to 9 kW (up to 36 kW when combined with a contactor box).
- Completely disconnect the control unit from the electrical circuit, i.e. flip all circuit breakers or the main circuit breaker during each installation or repair.
- Please note the safety and installation information from the sauna oven manufacturer.
- Always heed the specifications and instructions of the cabin manufacturer, too.
-  **If control units with remote control options* are used, protection against activation when the heater is covered is required. (e.g. cover protection Type 1-5 or S-Guard).**

**Telecontrol = setting up, controlling or adjusting a unit by a command that can be given out of view of the unit by means of transfer media such as telecommunication, audio technology or bus systems. (this also includes weekly timers)*



When designing the cabin ensure that the external exposed glass surfaces only reach a maximum temperature of 76°C. If necessary, protective features need to be fitted.



Attention!

Dear customer,
according to the valid regulations, the electrical connection of the sauna heater and the control box has to be carried out through the specialist of an authorized electric shop

We would like to draw your attention that in case of a warranty claim, you are kindly requested to present a copy of the invoice of the executive electric shop.

Installation of the control unit

Wall installation

The control unit may only be mounted outside the sauna cabin. It is advisable to select the outside wall of the cabin to which the sauna heater is fixed from the inside as mounting position. If ductwork is already provided for electrical installations then the position of the control unit is predetermined by that. Please follow the instructions for installation:

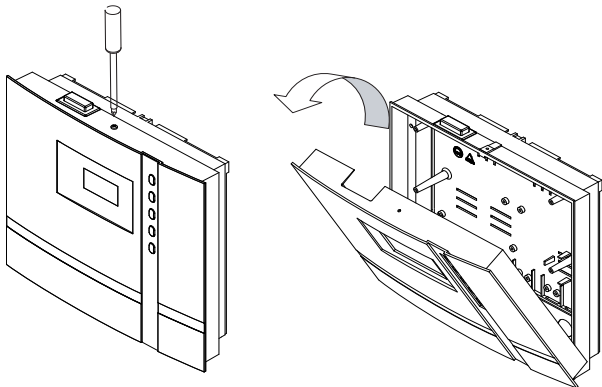

Fig. 1

Remove the control device cover. In order to do this loosen the screw at the top of the housing and pull the housing top upward while swivelling (Fig. 1).

Surface-mounted installation

1. The 3 mm diameter boreholes for the supplied wood screws 4 x 20 mm are drilled according to the dimensions shown in Fig. 3 + 3.1.
2. Insert one of the wood screws into the top center hole. The control unit is hooked onto this screw. Therefore, leave the screw out by approx. 3 mm (Fig. 3.2).
3. Hook the control unit onto the 3 mm protruding screw in the upper mounting hole. Insert the supplied rubber grommets into the openings at the rear wall of the housing and insert the connecting cable through these openings.

Fasten the housing bottom at the two bottom openings (Fig. 4) firmly to the cabin wall.

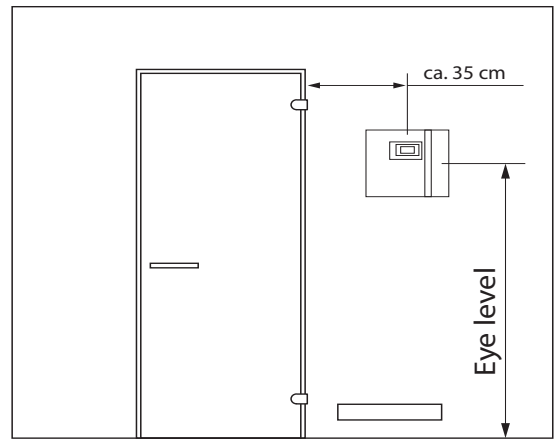

Fig. 3

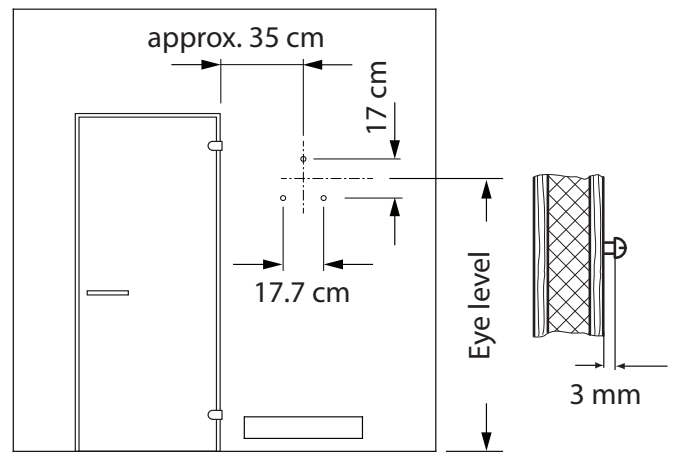

Fig. 3.1

Fig. 3.2

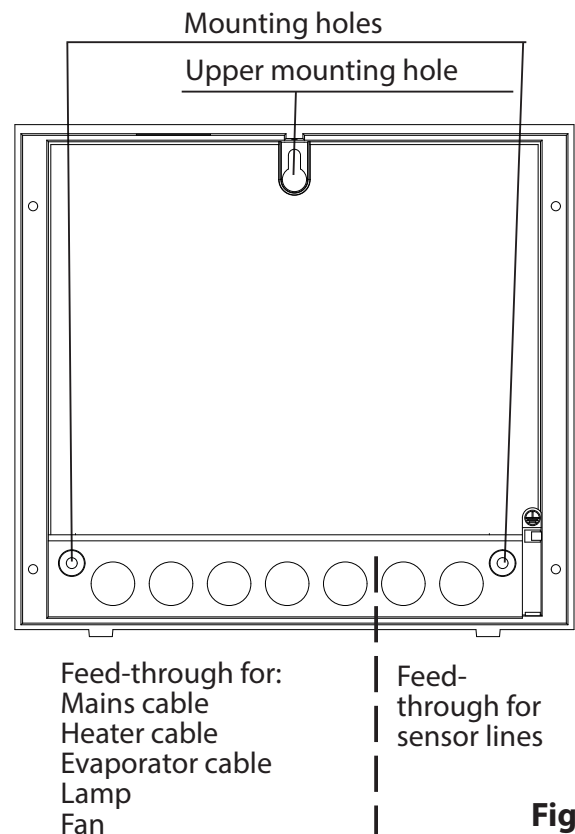

Fig. 4

Recessed installation

1. Cut out a wall section that is at least 3.5 cm deep according to the dimension in Fig. 5.

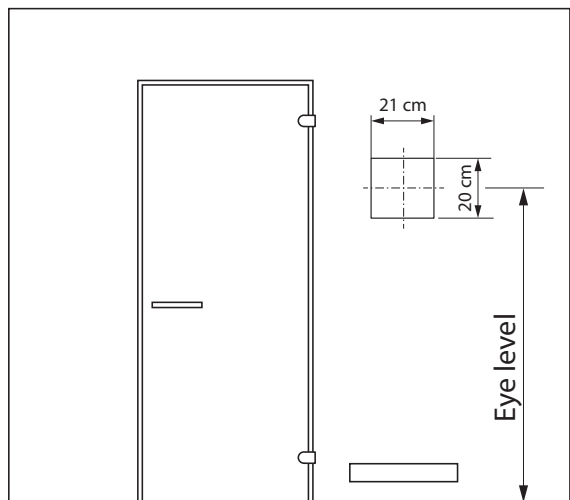

Fig. 5

Insert the supplied rubber grommets into the openings at the rear wall of the housing and insert the connecting cables through these openings.

Place the control unit into the wall opening and fasten it with 4 wood screws.

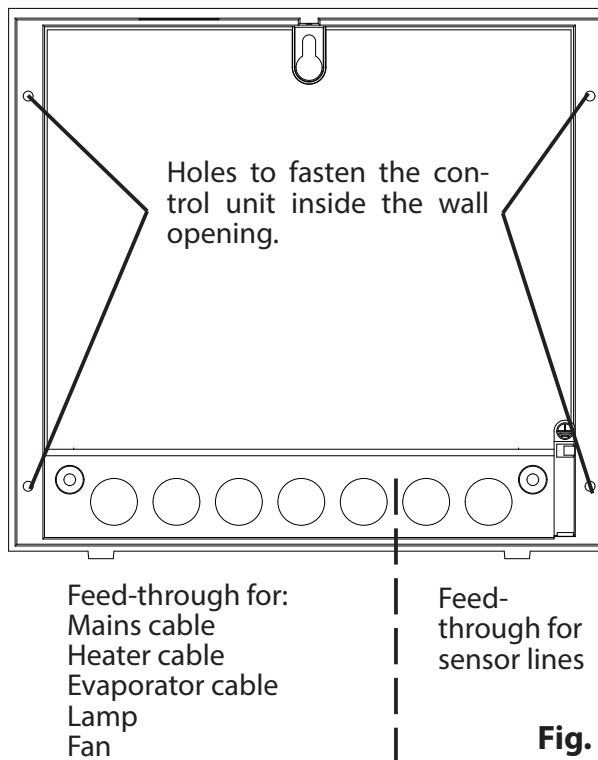

Fig. 6

Connection of the sensor cables

You should not lay sensor and power supply cables together, or draw them through the same feedthrough. This can lead to interferences in the electronics, such as “fluttering” in the relays, which may damage the control unit. If it is necessary to lay the cables down together, or if the line is longer than 3 m, use a shielded sensor cable (4 x 0.5 mm²).

Connect the shielding to ground in the control unit.

Please observe that the following dimensions relate to the values stipulated during the unit approval as per norm EN 60335-2-53. The heater sensor must always be installed at the point where the highest temperatures are to be expected. Illust. 7 - 9 give you an overview of the mounting point of the sensor.



Installation of the temperature sensor

1. Mount the oven sensor in cabins up to 2 x 2 m according to Fig. 7 and 9, in larger cabins according to Fig. 8 and 9.

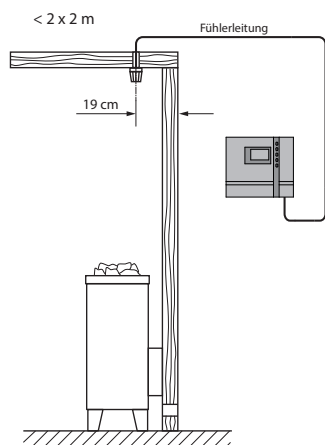

Fig. 7

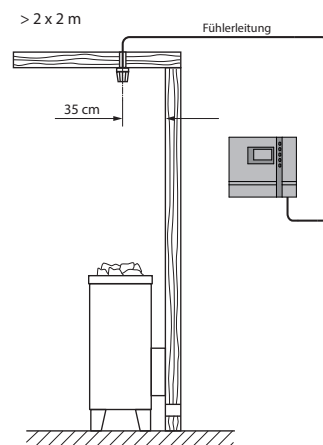

Fig. 8

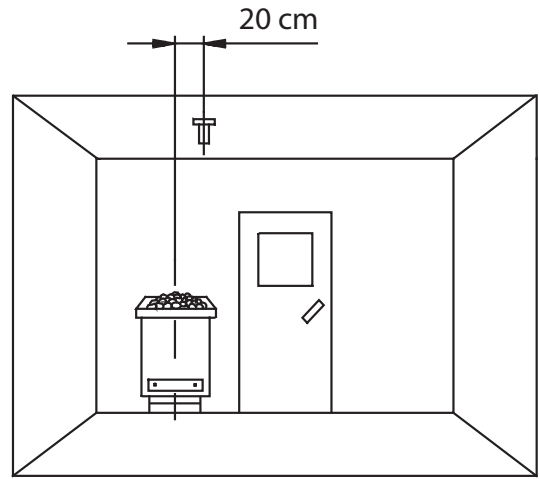

Fig. 9

2. Drill a hole in sauna ceiling panel to lead the cable through, preferably through the middle of one of the wooden boards.
3. Lead the sensor cable through the drilled hole and connect it to the sensor line according to Fig. 10.
4. The cables for the limiter fuse (white) and the temperature sensor (red) shall be connected to the sensor circuit board as per Fig. 10. Insert the sensor board into the casing.
5. Lead the sensor cables through the right-hand cable intake into the control unit. Lay the sensor cables inside the control unit as shown in Fig. 11. Connect the sensor cables to the board as shown in Fig. 12. In order to do this, pull the plug **X2** from the circuit board and plug it back in after the connection of the sensor.

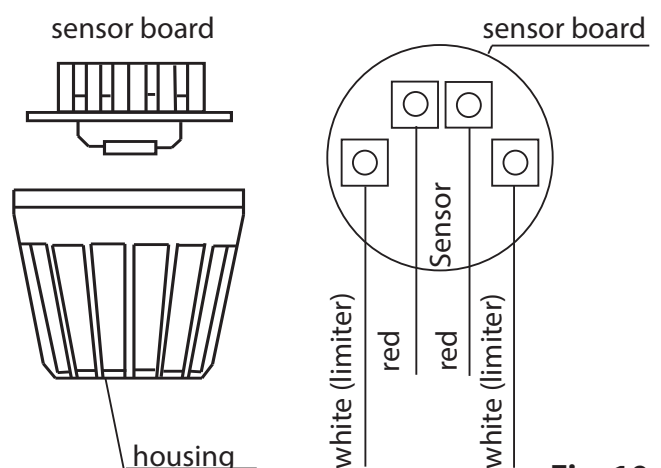

Fig. 10

Jumper for heating time limitation setting:
6 h, 12 h, unlimited

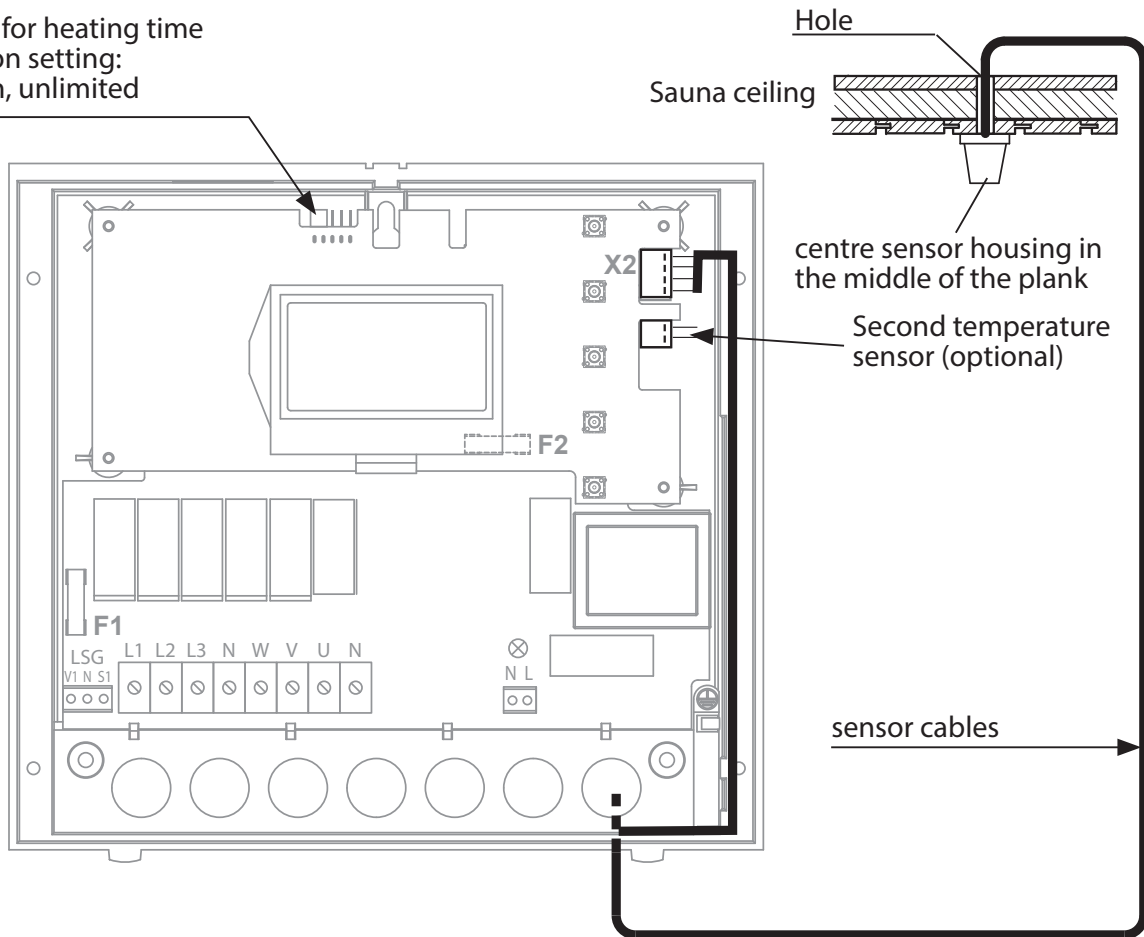

Fig. 11

Attention! Make sure not to confuse the sensor cables at X2 connector! This may cause the F2 fuse to burn, for replacement see page „replace device fuse“

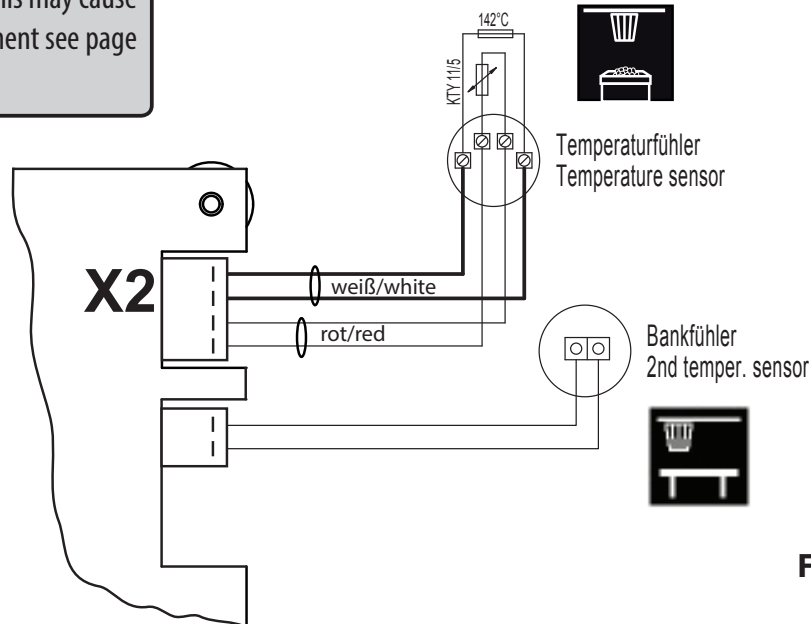
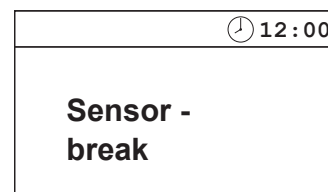
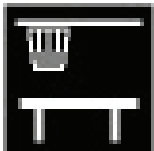

Fig. 12

6. After completed installation and correct commissioning of the control unit, the line for overtemperature protection must be checked for short-circuits. In order to do this, disconnect one of the white cables in the sensor casing. The respective error message shall appear in the display.



Example of the error message for overheating limiter fuse (DE)



Installation of the optional second temperature sensor (bench sensor)

Installation place: The bench sensor shall be mounted to the ceiling over the rear wall bench opposite to the heater as described in the installation of the bench sensor.

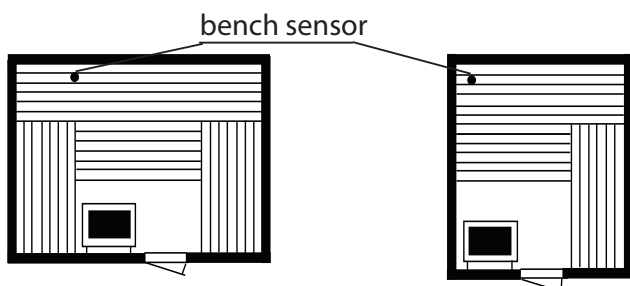

The bench sensor is connected with a 2-core silicone cable from the sensor pcb to the terminals on the right-hand side of the main board of the sauna controller (X2), as shown below.

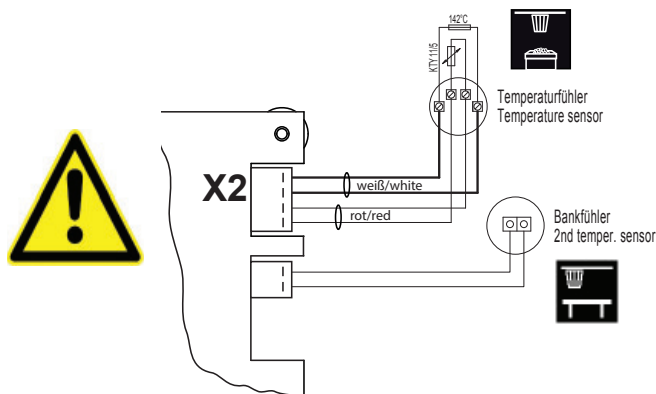

If the sensor is connected correctly, the control unit shall automatically recognise it once the mains voltage has been switched on again.

By faults of the second sensor the following error messages will be displayed:

„**Sensor break**“ - interruption of the sensor circuit (e.g. faulty contact).

or

„**Sensor short**“ - short circuit of the sensor

In this case, the sensor must be checked by a specialist and replaced if necessary. At room temperature 20 °C, the sensor has approx. 2 kΩ resistance.

In order to keep on operating your sauna cabin despite the second sensor fault switch the unit from power supply, disconnect the cable connection to the second sensor and restore the power supply.

Once the problem has been solved, the control unit shall recognise the sensor after it has been re-connected and the mains voltage has been switched on again

Electrical connection

The electrical connections may only be carried out by a certified electrician in compliance with the guidelines of the local power supply company and applicable legal regulations (e.g. VDE norms for Germany).

In general, there may be only one permanent connection line to the network. Furthermore equipment should be provided that makes it possible to disconnect the system on all phases from the power supply with a contact gap of minimum 3 mm.

All electrical installations and all connection lines that are installed inside the sauna cabin must be suitable for an ambient temperature of at least 170 °C.

The power supply line shall be laid to the control unit and connected to the power input terminals.



Connection of the sauna heater

Install the sauna heater and the vaporizer in front of the air intake according to the manufacturer's installation instructions.

Run the silicone line through the ductwork to the power unit and connect it to the appropriate terminals as directed in the wiring diagram.

Note: In case there is no ductwork available drill a hole next to the air intake opening and run the heater line through this hole to the outside and to the appropriate terminals in the control unit. The silicone line must be buried to protect it from outside influences. Therefore, use a suitable cable-duct or a PVC-pipe through which you can run the line up to the power unit.

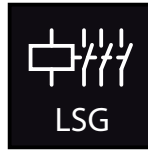

Connection of the power extension unit (LSG)

For details refer to the installation instructions of the respective LSG device.

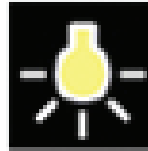

Connection of the sauna lamp

The sauna lamp must have the protection class of at least IPx4 and should be resistant to the ambient sauna temperatures. The sauna lamp may be installed at any location but never close to the rising hot air of the heater.

Only heat resistant bulbs or other suitable illuminants may be used.

Installation diagram

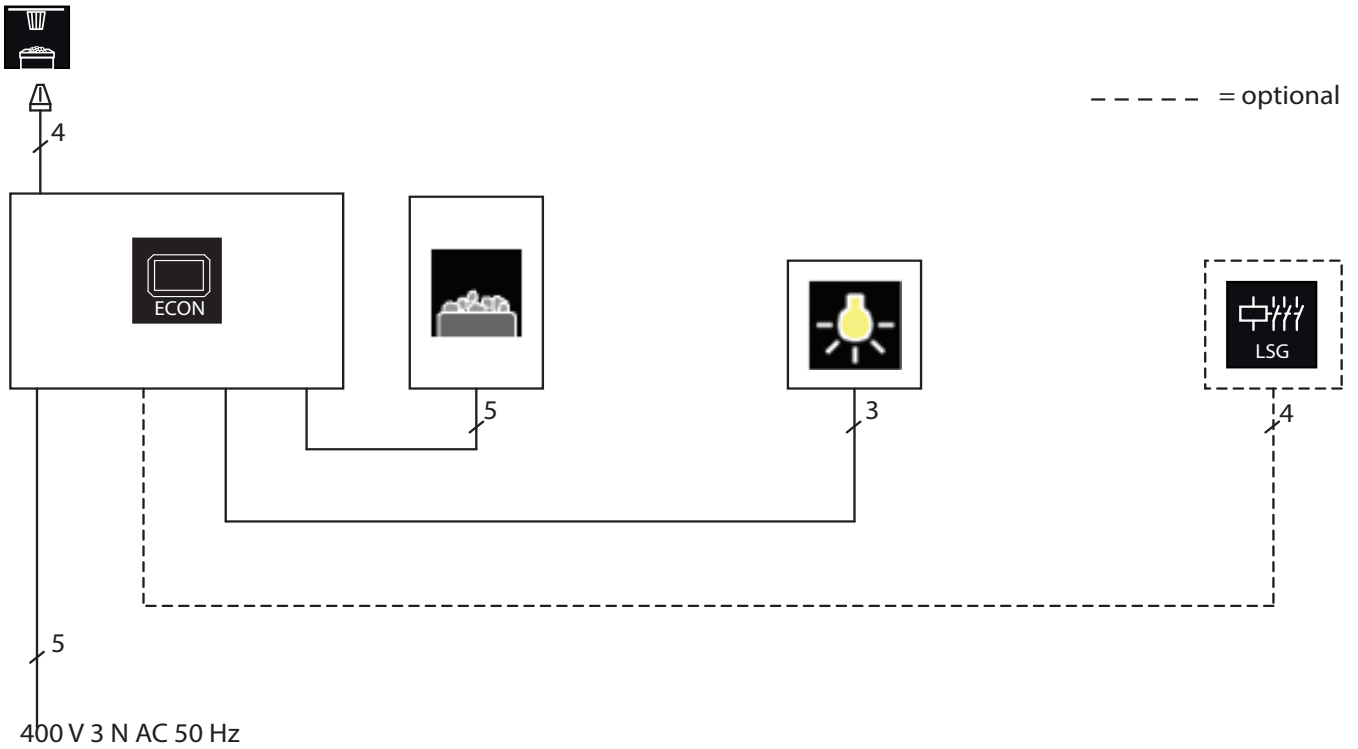

Terminal layout on the main board

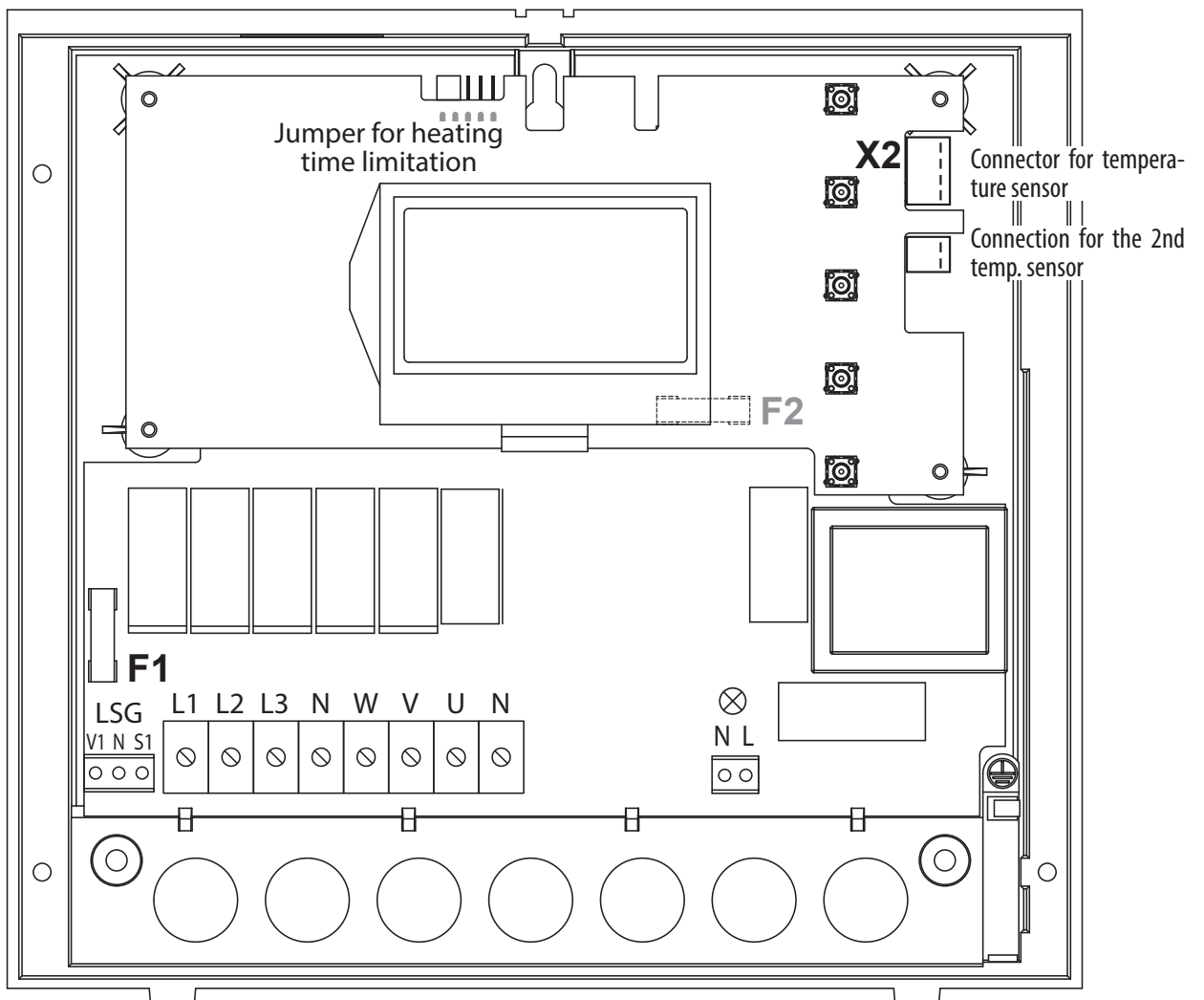

Connection of sauna heaters up to 9 kW

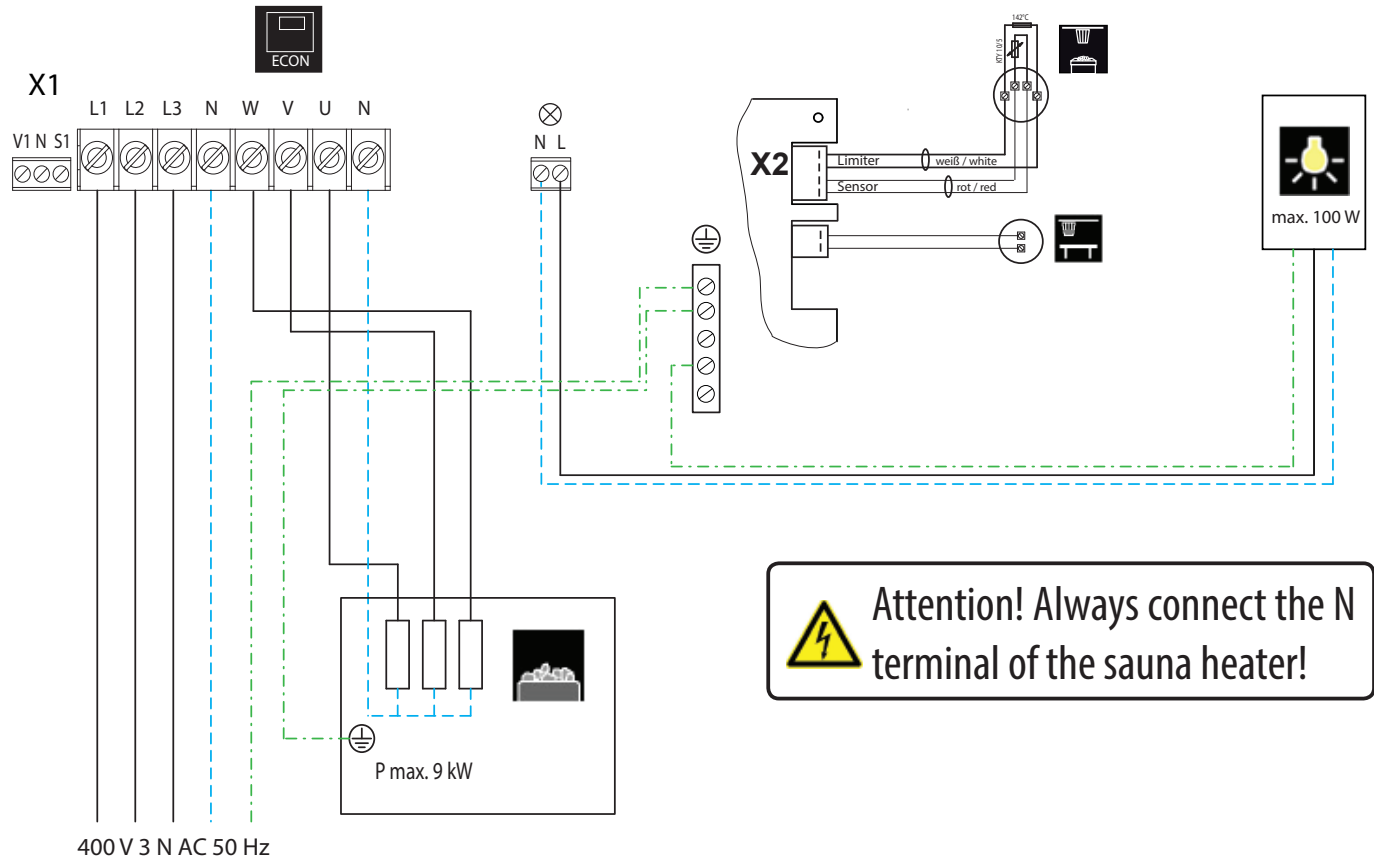

Connection of sauna heaters above 9 kW

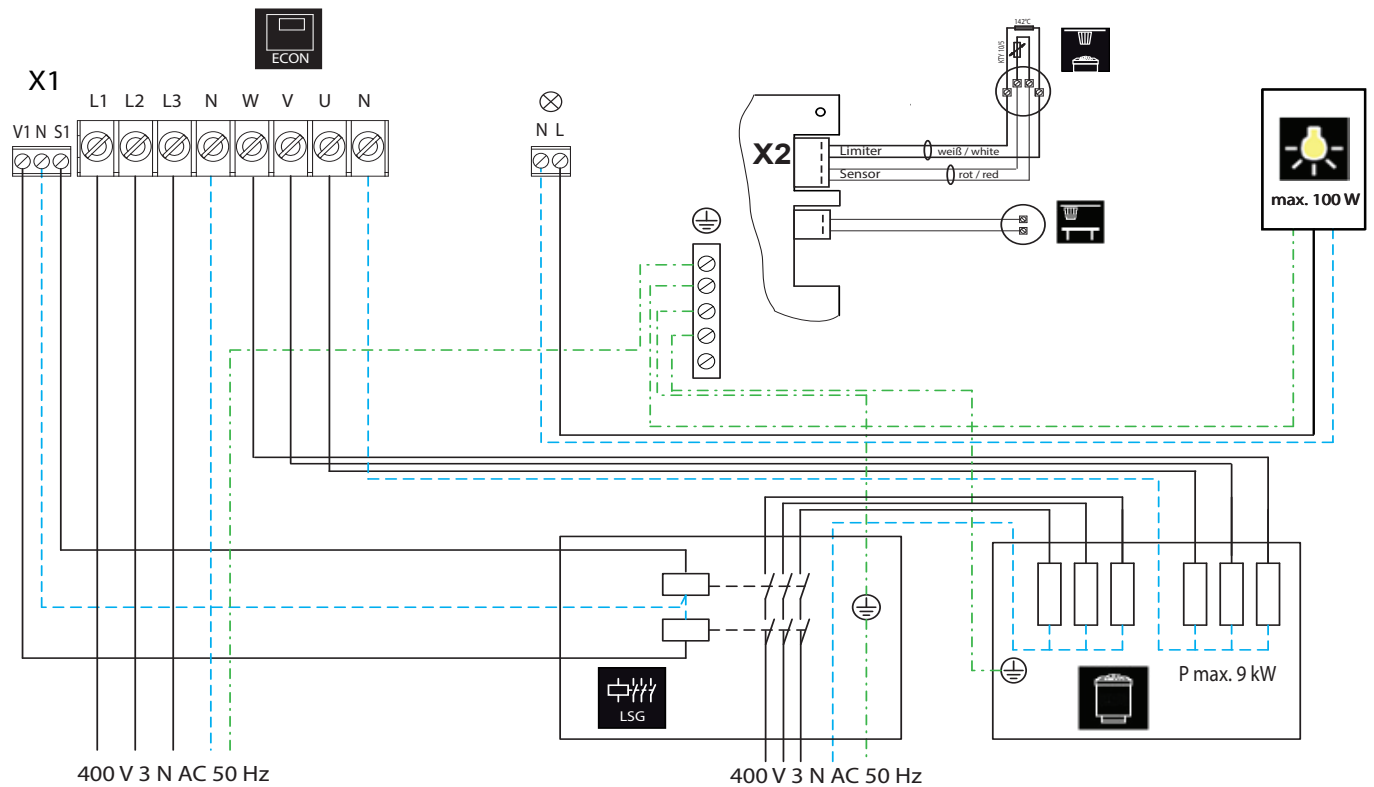

Operation

Once the control unit has been installed with all components and all covers have been fixed, you can put your sauna unit into operation.

The following pages provide the detailed explanation, how to operate your control panel and make all necessary settings.

General details

Operation elements

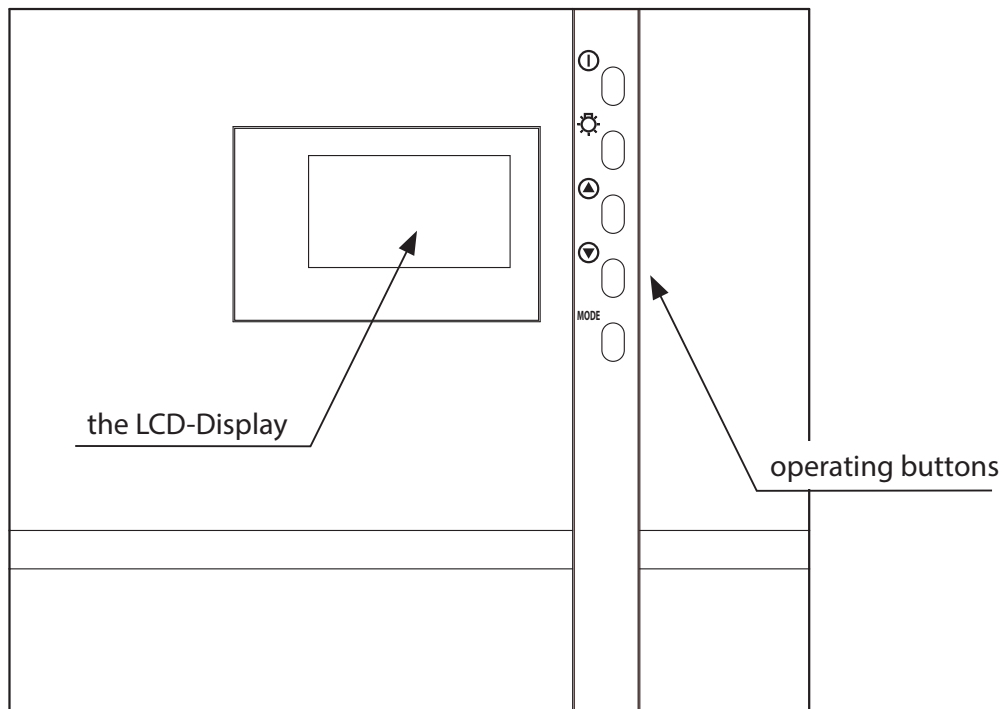

Operating buttons

 = Sauna heating on / off (stand-by)

 = Sauna cabin lighting

 = Reduce value / next function

 = Increase value / next function

MODE = Programming mode (settings)

Interface in Stand by

is shown if the control unit is in stand-by model
The display will automatically switch this interface from any state if no button has been pressed within >15 Sek.

	🕒 12 : 00
Temperature	30°C
Auto-stop	5 : 59
Start time	-- : --

Interface in active operation

is shown if the control unit is in active operation mode (heating is switched on).

The display will automatically switch this interface from any state if no button has been pressed within >15 Sek (during active heating).

☀️	🕒 12 : 15
Temperature	30°C
Auto-stop	5 : 59
Start time	-- : --

Display of the heating process:

During the heating-up phase the bars behind the temperature figures will fill progressively.

Once the pre-set temperature has been reached, the bars will remain filled.



Interface in energy-saving mode

If the control unit is not used for a longer time it will switch into the energy-saving mode.

A clock randomly moving across the display every minute will be shown after 5 minutes, similar to a PC screensaver. The backlight of the display is switched off after an additional 15 minutes

By pressing any key you can wake the unit to the default "Stand-by" interface.



The following applies for all settings:

The following symbols are displayed at the top.



the light symbol
(when the light is on)



the clock symbol

12 : 00

current time

In addition, the following symbols are displayed depending on the selected operating mode.



active child lock (keypad lock)



preset time (switching time preselection)

In order to adjust the individual values to the particular desires, briefly push the **MODE** -button out of Stand-by.

The modifiable parameter will then be highlighted in black and it is possible to select with the ▲ or ▼ - buttons the desired parameter.

🕒 12:15	
Temperature	30°C
Auto-stop	5:59
Start time	--:--

Parameters that blink on the display can be changed and are shown in these instructions as displayed.

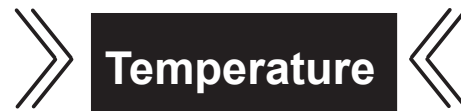

By pushing the **MODE** -button again you will arrive at the programming level.

The name of the parameter is now blinking and the modifiable value is highlighted in black.

The value highlighted in black can now be changed with the ▲ or ▼ the - buttons.

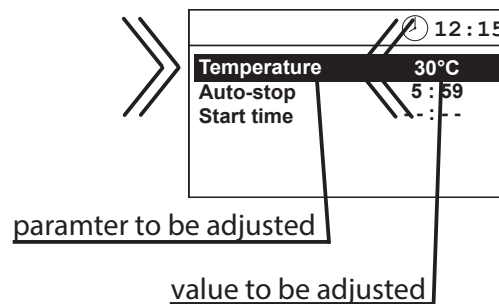

All settings out of Stand-by are confirmed by pressing **MODE** >3 s and are saved in the memory of the unit.

The blinking of the parameter ends and the new value is now authoritative until another change is made.

🕒 12:15	
Temperature	30°C
Auto-stop	5:59
Start time	--:--

If no button is pressed for >15 seconds the unit switches back to the default display. Changes made up to then will not be saved

Sauna cabin lighting

The cabin lighting is automatically switched on as soon as the sauna unit is switched on. In the top left of the display the ☀ - symbol is shown. When the sauna unit is switched off the cabin lighting will switch off with a delay of 30 minutes.

☀	🕒 12:15
Temperature	30°C
Auto-stop	5:59
Start time	--:--

Irrespective of the status of the sauna unit, the cabin lighting can be ☀ switched on or off any-time with the button.

Initial commissioning

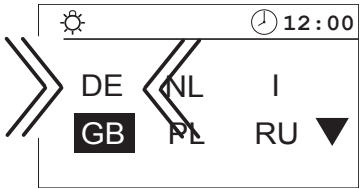
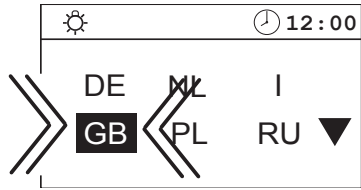

MODE > 3 Sek

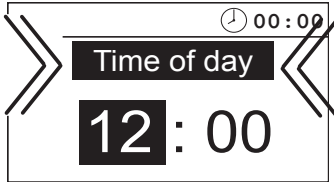

MODE



MODE > 3 Sek

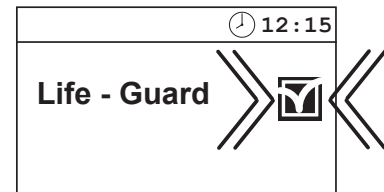
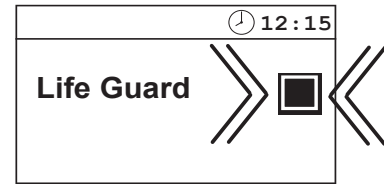

MODE > 3 Sek

🕒 12:00	
Temperature	30°C
Auto-stop	5 : 59
Start time	- : - :
Life - Guard	20 min

Change language

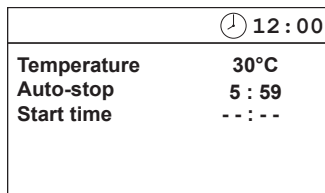

MODE &

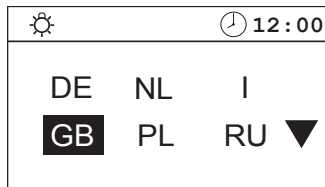

MODE

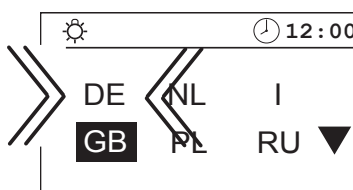
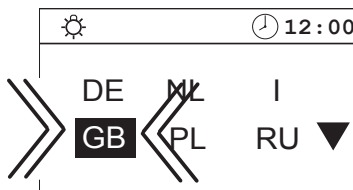

MODE > 3 Sek



Set (change) time

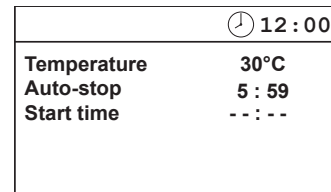

MODE &

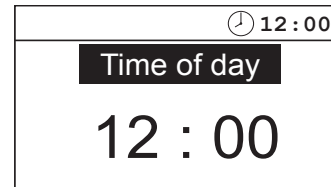

MODE



MODE

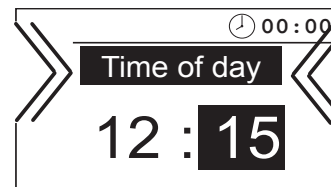

MODE > 3 Sek

Activate Life-Guard function

Life-Guard is a settable relatively short time, e.g. 20 minutes, after which the sauna heater will be switched off, except for the cabin lighting, if this function has been activated. After this time has elapsed the heater can be switched on again by pushing the **MODE** - button for the set time.



In order to use this function you need to activate it in the set-up menu. This may be done either during initial commissioning or later in normal operation.

🕒 12:00	
Temperature	30°C
Auto-stop	5:59
Start time	--:--



MODE & 

🕒 12:15	
Time of day	
12:15	

 / 

🕒 12:15	
Life Guard	  



🕒 12:15	
Life - Guard	  

MODE > 3 Sec

🕒 12:00	
Temperature	30°C
Auto-stop	5:59
Start time	--:--
Life - Guard	20 min

Activate / deactivate the child lock

If the child lock is activated (the key symbol is visible in the top section of the display) only the cabin lighting can be switched. All other buttons are without function. Activation / deactivation of the child lock can be done in stand-by as well as in operation mode. The unit can still be switched off if in operation mode.

Activate

Stand by

🕒 12:00	
Temperature	30°C
Auto-stop	5:59
Start time	--:--

Operation

🕒 12:15	
☀️	
Temperature	30°C 
Auto-stop	5:59
Start time	--:--

 &  > 3 Sec

🕒 12:00	
🔑	
Temperature	30°C
Auto-stop	5:59
Start time	--:--

🕒 12:15	
☀️ 🔑	
Temperature	30°C 
Auto-stop	5:59
Start time	--:--

Deactivate

🕒 12:00	
🔑	
Temperature	30°C
Auto-stop	5:59
Start time	--:--

🕒 12:15	
☀️ 🔑	
Temperature	30°C 
Auto-stop	5:59
Start time	--:--

 &  > 3 Sec

🕒 12:00	
Temperature	30°C
Auto-stop	5:59
Start time	--:--

🕒 12:15	
☀️	
Temperature	30°C 
Auto-stop	5:59
Start time	--:--

Switching on the sauna heater

🕒 12:00	
Temperature	30°C
Auto-stop	5:59
Start time	--:--

🔌 > 3 Sec

⚙️ 🕒 12:15	
Temperature	30°C 📶
Auto-stop	5:59
Start time	--:--

Switching the heater with Life-Guard function

🕒 12:00	
Temperature	30°C
Auto-stop	5:59
Start time	--:--
Life - Guard	20 min

🔌 > 3 Sek

⚙️ 🕒 12:15	
Temperature	30°C 📶
Auto-stop	5:59
Start time	--:--
Life - Guard	20 min

The sauna heater is now heating normally, without "Life - Guard"-time. To activate the function "Life - Guard".

MODE

⚙️ 🕒 12:15	
Temperature	30°C 📶
Auto-stop	5:59
Start time	--:--
Life - Guard	20 min

Switching off the sauna heater

⚙️ 🕒 12:15	
Temperature	30°C 📶
Auto-stop	5:59
Start time	--:--

Auto-Stop time / 🔌

⚙️ 🕒 12:00	
Temperature	30°C
Auto-stop	5:59
Start time	--:--

After expiration of the "Life - Guard" - time the sauna heater is switched off and the entire display blinks:

⚙️ 🕒 12:15	
Temperature	30°C 📶
Auto-stop	5:59
Start time	--:--
Life - Guard	20 min

Restart heating:

MODE

🕒 12:00	
Temperature	30°C
Auto-stop	5:59
Start time	--:--
Life - Guard	20 min

Or switch the sauna heater off:



🕒 12:00	
Temperature	30°C
Auto-stop	5:59
Start time	--:--
Life - Guard	20 min

Notice:

In Life-Guard mode it is not possible to change the temperature or humidity settings as long as the control unit is in operation (active heating).

Individual settings

Hereafter we are showing you the options that allow you to adjust the controls to your individual needs. The various parameters can be changed in Stand-by or in operation and the changes are saved in the unit. Changes in settings made during operation will be applied directly as they are made.

Sauna temperature Control range: dry Finnish mode 30 - 115°C

In Stand-by

🕒 12:00	
Temperature	30°C
Auto-stop	5:59
Start time	--:--

MODE

🕒 12:15	
Temperature	30°C
Auto-stop	5:59
Start time	--:--

MODE

🕒 12:15	
Temperature	30°C
Auto-stop	5:59
Start time	--:--



🕒 12:15	
Temperature	85°C
Auto-Stop	5:59
Vorwahlzeit	--:--

MODE > 3 sec

🕒 12:15	
Temperature	85°C
Auto-stop	5:59
Start time	--:--

15 sec. / 🔌 > 3 sec

🕒 12:00	
Temperature	85°C
Auto-stop	5:59
Start time	--:--

🕒 12:15	
Temperature	85°C
Auto-stop	5:59
Start time	--:--

In operation

🕒 12:15	
Temperature	30°C
Auto-stop	5:59
Start time	--:--

MODE

🕒 12:15	
Temperature	30°C
Auto-stop	5:59
Start time	--:--

MODE

🕒 12:15	
Temperature	30°C
Auto-stop	5:59
Start time	--:--



🕒 12:15	
Temperature	85°C
Auto-stop	5:59
Start time	--:--

MODE > 3 sec.

🕒 12:15	
Temperature	85°C
Auto-stop	5:59
Start time	--:--

15 sec

🕒 12:15	
Temperature	85°C
Auto-stop	5:59
Start time	--:--

Life-Guard

Here you can set after what time the sauna heater shall be switched off and by pushing the **MODE** - button again you can restart the heating for the pre-set "Life-Guard" time.

This setting can only be selected in Stand-by when the function "Life - Guard" is activated.

For instance you set 15 min time. If you do not press the **MODE** button within 15 minutes during active heating, the heater will switch off once this time expires. If you press the „mode“ button, the heating will resume for the next 15 minutes.

This feature provides you a convenience of a quick timer and is independent to the general heating time limitation (auto-stop).

In Stand-by

🕒 12:00	
Temperature	30°C
Auto-stop	5 : 59
Start time	-- : --
Life - Guard	20 min

MODE

🕒 12:00	
Temperature	30°C
Auto-stop	5 : 59
Start time	-- : --
Life - Guard	15 min

15 sek. / 🔌 > 3 Sec

🕒 12:00	
Temperature	30°C
Auto-stop	5 : 59
Start time	-- : --
Life - Guard	20 min



🕒 12:00	
Temperature	30°C
Auto-stop	5 : 59
Start time	-- : --
Life - Guard	15 min

🕒 12:15	
Temperatur	30°C 📶
Auto-Stop	5 : 59
Vorwahlzeit	-- : --
Life - Guard	14 min

🕒 12:00	
Temperature	30°C
Auto-stop	5 : 59
Start time	-- : --
Life - Guard	20 min

MODE

🕒 12:00	
Temperature	30°C
Auto-stop	5 : 59
Start time	-- : --
Life - Guard	20 min



🕒 12:00	
Temperature	30°C
Auto-stop	5 : 59
Start time	-- : --
Life - Guard	15 min

MODE

Auto-Stop (heating time limitation)

Auto-Stop is the time to which the heating time is limited. The sauna heater automatically turns off once this time has expired.

The time is adjustable from 0:01 to 6:00 hours. The extension of this time is possible with the jumper setting and may be carried out only the specialist dealer. Please notice that such extension is only permitted for commercial sauna cabins (supervised commercial sauna cabins).

In stand-by

🕒 12:00	
Temperature	30°C
Auto-stop	5:59
Start time	---:--

MODE

🕒 12:15	
Temperature	30°C
Auto-stop	5:59
Start time	---:--



🕒 12:15	
Temperature	30°C
Auto-stop	5:59
Start time	---:--

MODE

🕒 12:15	
Temperature	30°C
Auto-stop	5:59
Start time	---:--



🕒 12:15	
Temperature	30°C
Auto-stop	3:59
Start time	---:--

MODE

🕒 12:15	
Temperature	30°C
Auto-stop	3:59
Start time	---:--



In operation

🕒 12:15	
Temperature	30°C
Auto-stop	5:59
Start time	---:--

MODE

🕒 12:15	
Temperature	30°C
Auto-stop	5:59
Start time	---:--



🕒 12:15	
Temperature	30°C
Auto-stop	5:59
Start time	---:--

MODE

🕒 12:15	
Temperature	30°C
Auto-stop	5:59
Start time	---:--



🕒 12:15	
Temperature	30°C
Auto-stop	3:59
Start time	---:--

MODE

🕒 12:15	
Temperature	30°C
Auto-stop	3:59
Start time	---:--



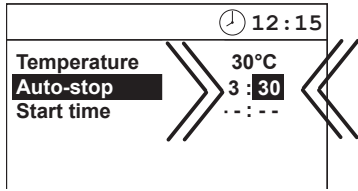

MODE > 3 sec.

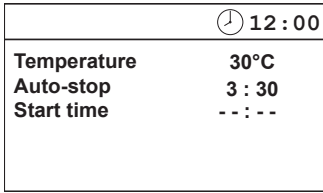

15 sek. / > 3 sec

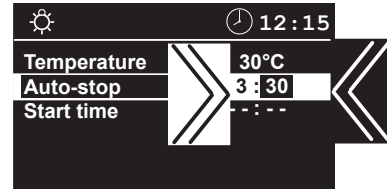

MODE > 3 sec

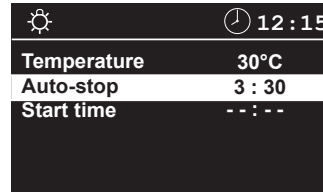

15 sec. /

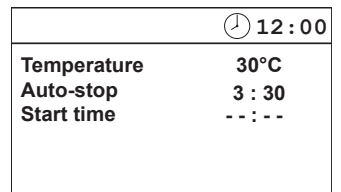
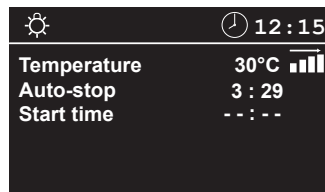
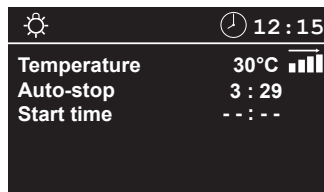
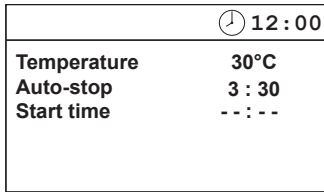

Preselection time (pre-set timer)

Using the time preselection, you can preselect a switch-on time within 24 hours in advance for your sauna heater.



Always make sure that there are no objects on the sauna unit before the heating process begins. Fire risk!

Please remember that a typical sauna cabin must heat up for approx. 40 - 50 minutes in order to achieve a pleasant bathing climate. If, for example, you wish to start with your sauna bath at 18:00, then we recommend to select approx. 17:10 as your preselection time.

The pre-heating time may vary strongly depending on the sauna cabin and sauna heater.

In stand-by

	🕒 12:00
Temperature	30°C
Auto-stop	5:59
Start time	--:--

MODE

	🕒 12:15
Temperature	30°C
Auto-stop	5:59
Start time	--:--



	🕒 12:15
Temperature	30°C
Auto-stop	5:59
Start time	--:--

MODE

	🕒 12:15
Temperature	30°C
Auto-stop	5:59
Start time	--:--



	🕒 12:15
Temperature	30°C
Auto-stop	5:59
Start time	17:--

MODE

In operation

☀️	🕒 12:15
Temperature	30°C 📶
Auto-stop	5:59
Start time	--:--

MODE

☀️	🕒 12:15
Temperature	30°C
Auto-stop	5:59
Start time	--:--



☀️	🕒 12:15
Temperature	30°C
Auto-stop	5:59
Start time	--:--

MODE

☀️	🕒 12:15
Temperature	30°C
Auto-stop	5:59
Start time	--:--



☀️	🕒 12:15
Temperature	30°C
Auto-stop	5:59
Start time	17:--

MODE

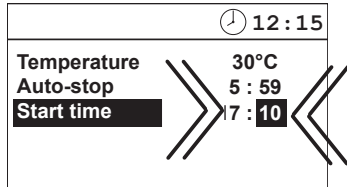
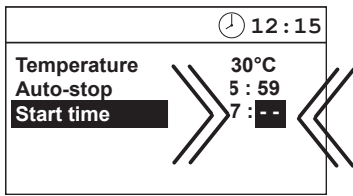

MODE > 3 sec

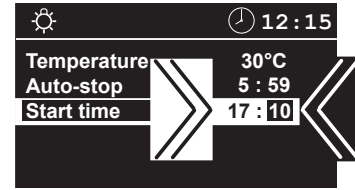
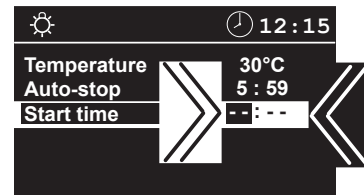
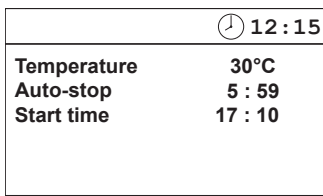

MODE > 3 sec

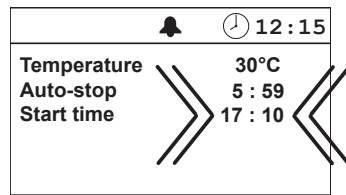
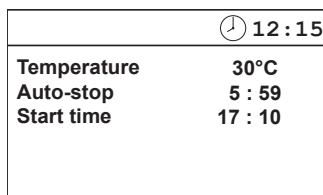
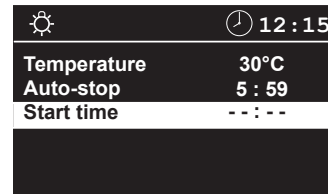

to preselected time

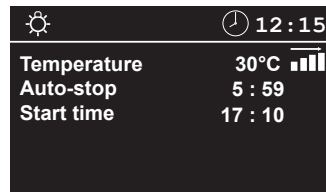
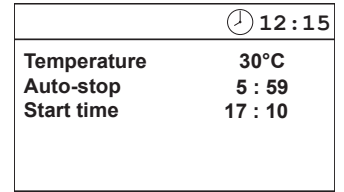
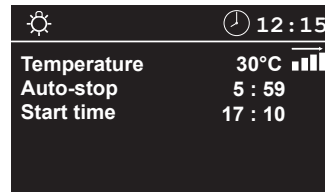

Activate the preselction time

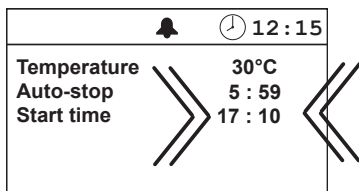

to preselected time

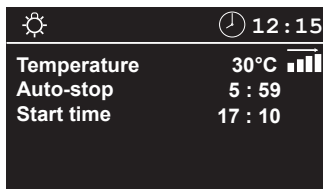

Deactivate the preselction time

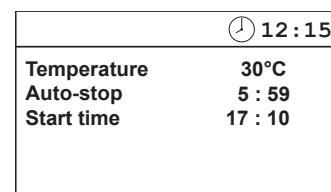
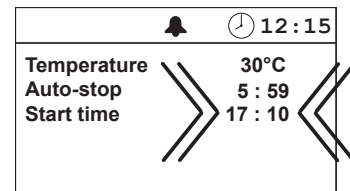





Extend heat-up time restriction / replace device fuse

By switching a jumper you can extend the time setting for sauna time from 6:00 to 12:00 hours or to unlimited operation time. Please notice that such extension is only permitted for certain commercial sauna cabins and may be restricted by the local legal regulations.

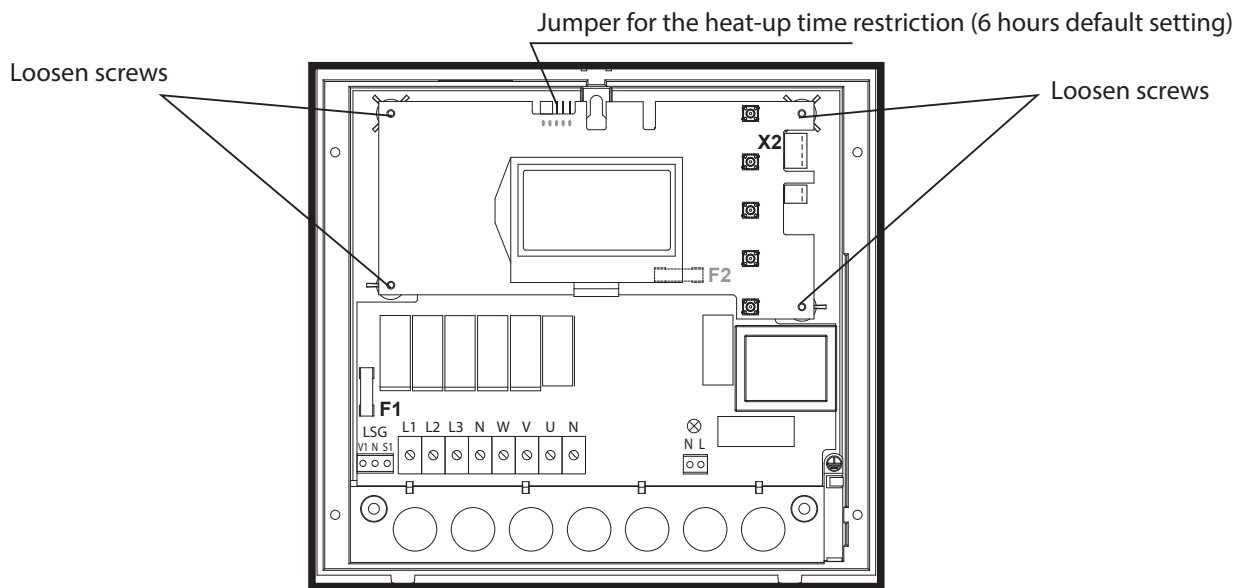
⚠ Such work must be carried out exclusively by an expert. Prior to any kind of work disconnect the control unit from the power supply on all phases. (Switch off main switch, or trip the ground circuit breaker). **Risk of electric shock!**

Open the control unit. The jumper is located in the middle of the top edge of the mainboard. Set jumper to the required position. Close the control unit. Restore the power supply.



- Jumper  6:00 hours heating time limitation (factory default)
- Jumper  12:00 hours heating time limitation
- Jumper  no heating time limitation

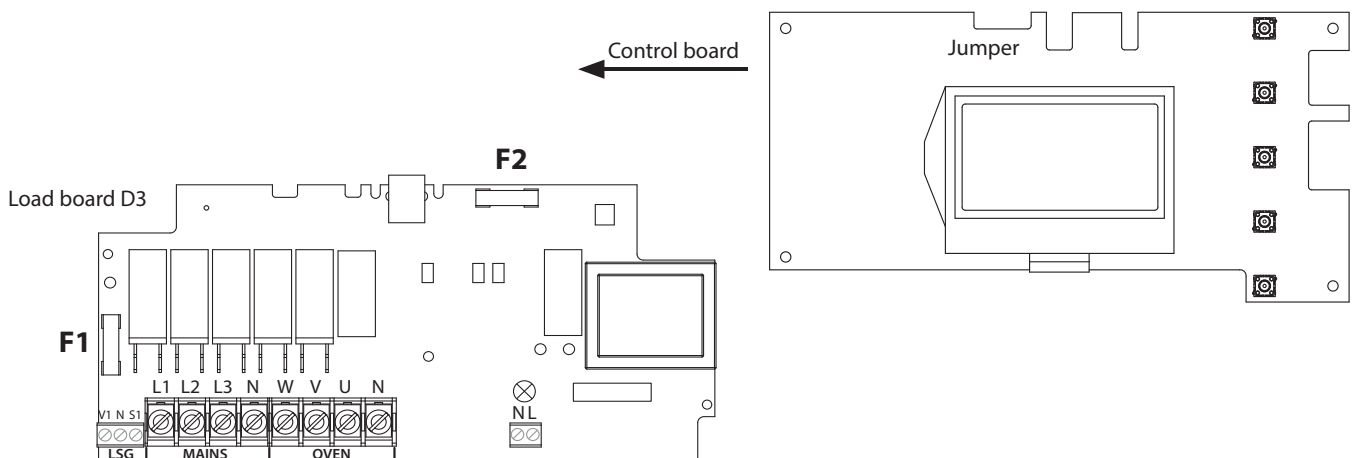

Unit fuses

- F1 = T 2A Fuse electronics primary and light and fan
- F2 = T 315 mA Fuse of the electronics secondary

Error messages

The control unit continuously monitors the sensor for short circuits and interruptions. At the same time, the system checks to ensure that there is enough water in the vaporizer tank.

The error messages appear as follows:

Display	Cause	Remedy
<div style="text-align: right;">🕒 12:00</div> <p>Fuehler - bruch</p>	<p>= interrupted room sensor circuit</p> <p>The temperature sensor (PTC) is faulty, or the line to the temperature sensor is interrupted.</p>	<p>Arrange for a specialist to check the lines and PTC. PTC at 20°C approx. 1.9 kΩ ρεπλαχε ιφ νεχεσσαρψ.</p>
<div style="text-align: right;">🕒 12:00</div> <p>Fuehler - schluss</p>	<p>= short-circuit in the room sensor circuit</p> <p>temperature sensor (PTC) is faulty, or the line to the temperature sensor has a short circuit.</p>	<p>Arrange for a specialist to check the lines and PTC.</p>
<div style="text-align: right;">🕒 12:00</div> <p>Thermo - sicherung</p>	<p>= interrupted limiter circuit</p> <p>The temperature fuse (142°C) has triggered or the line to the temperature fuse is interrupted.</p>	<p>Arrange for a specialist to check the lines and temperature fuse.</p>
<div style="text-align: right;">🕒 12:00</div> <p>Bankfühler - bruch</p>	<p>= interrupted bench sensor</p>	<p>Arrange for a specialist to check the lines and PTC. PTC at 20°C approx. 1.9 kΩ ρεπλαχε ιφ νεχεσσαρψ.</p>
<div style="text-align: right;">🕒 12:00</div> <p>Bankfühler - schluss</p>	<p>= short circuit bench sensor</p>	<p>Arrange for a specialist to check the lines and PTC. PTC at 20°C approx. 1.9 kΩ ρεπλαχε ιφ νεχεσσαρψ.</p>

The device „Switch-off“ switch

You will find the rocker switch on the top side of the control unit. You can completely disconnect the control unit from the mains using this switch.

Switch-off by ECON control units

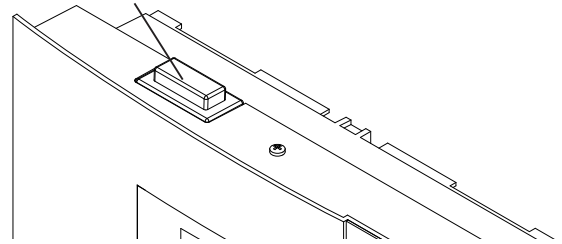

Switch-off

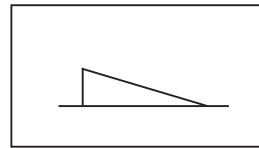

Unit turned on
(default Position I)

Press the switch on the left side of the rocker to the first latch (**switch setting 0**). The switch will be in the middle position. The unit is now completely switched off (disconnected).

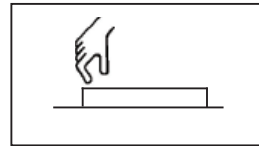

Unit fully switched off
Position 0.

To turn the light on in the cabin while the unit is still disconnected push the left side of the rocker to the second latch (**switch setting II**).

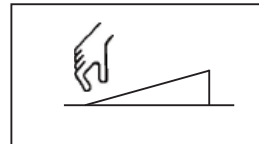

Light switched on;
Unit switched off.
Position II.

To make the unit ready for operation, switch back to the initial position (**switch setting I**). The unit will return to stand-by mode.

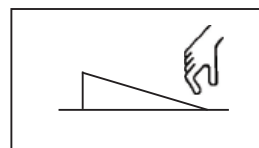

Unit switched on.
Position I.

Please keep this address in a safe place together with the installation guide.

To help us answer your questions quickly and competently please provide the information printed on the type shield including the model, item no. and serial no., in all inquiries.

Service Address:

EOS Saunatechnik GmbH
Schneiderstriesch 1

35759 Driedorf, Germany

Tel: +49 (0)2775 82-514

Fax: +49 (0)2775 82-431

servicecenter@eos-sauna.de

www.eos-sauna.de

WARRANTY

The warranty is provided according to the legal regulations at present.

Manufacturer's guarantee:

- The period of guarantee starts from the date of purchase and lasts up to 2 years by commercial use and 3 years by private use.
- Always include the completed guarantee certificate when returning equipment.
- The guarantee is void for appliances which have been modified without manufacturer's explicit agreement.
- Damages caused by incorrect operation or handling through non-authorized persons are not covered under the terms of guarantee.
- In the event of a claim please indicate the serial number as well as the item number and model name with detailed description of the fault.
- This guarantee covers defective parts and labour but not the defects caused by wear and tear.

In case of complaint please return the equipment in its original packaging or other suitable packaging (caution: danger of transport damage) to our service department.

Always include the completed warranty certificate when returning equipment.

Possible shipping costs arising from the transport to and from point of repair cannot be overtaken by us.

Outside of Germany please contact your specialist dealer in case of warranty claims. Direct warranty processing with our service department is in this case not possible.

Equipment commissioning date:

Stamp and signature of the authorized electrician:

General Terms and Conditions of Service

I. Scope

Unless otherwise agreed in writing in a specific case, these terms and conditions of service shall apply to service operations, including examining and repairing complaints. All our existing or future legal relationships shall be governed solely by the following terms and conditions of service. Our recognition of any conflicting terms and conditions of the Ordering Party shall be conditional upon our having given our express written consent to their applicability. We hereby expressly object to any terms and conditions of the Ordering Party contained in its General Terms and Conditions of Business or order confirmation. If order confirmations or deliveries are accepted without reservation, this shall not be deemed to constitute recognition of such terms and conditions. Any ancillary agreements or amendments must be confirmed in writing.

II. Prices and Payment Terms

The Ordering Party shall bear the following costs in connection with the service operation:

- Disassembly/assembly and electrical (de-) installation
- Transportation, postage and packaging
- Function testing and troubleshooting including inspection and repair costs

There shall be no third-party billing.

III. Performance Obligations / Ordering Party's Cooperation

The Ordering Party shall provide free-of-charge assistance to the manufacturer in carrying out the service operation.

In the case of a warranty claim, the manufacturer shall make the replacement parts necessary for the service available to the Ordering Party free of charge.

IV. Service Visit by the manufacturer

In the event that it is essential that a manufacturer employee carry out the service operation on site, this must be agreed in advance. Where the main reason for the service call is not the fault of the manufacturer, any costs incurred shall be recharged to the Ordering Party after the service visit.

V. Liability

The manufacturer shall assume liability in accordance with the currently applicable statutory regulations. The packaging for all of our products is designed for the shipping of individually packed goods (pallet). We expressly point out that our packaging is not suitable for individual

shipments via parcel post. The manufacturer shall accept no liability for damage incurred as a result of improper packaging in an individual shipment.

VI. Manufacturer's Warranty

The manufacturer's warranty shall apply only in the event that installation, operation and maintenance have been carried out in accordance with the manufacturer's specifications contained in the assembly instructions and instructions for use.

- The warranty period shall commence from the date on which proof of purchase is provided and shall be limited, in principle, to 24 months.
- Warranty services shall be performed only if the proof of purchase relating to the equipment can be presented.
- Any and all warranty claims shall become void if modifications are made to the equipment without the manufacturer's express consent.
- Any warranty claim shall likewise become void in the case of defects that arise due to repairs or interventions made by unauthorized persons or due to improper use.
- In the case of warranty claims, the serial and article numbers must be indicated together with the designation and a meaningful description of the fault.
- This warranty shall cover defective equipment parts, with the exception of normal wear parts. Wear parts shall include, among other things, light sources, starters, gas or oil pressure dampers as well as acrylic glass panes, tubular heating elements and sauna heater stones.
- Only original replacement parts may be used within the warranty.
- Service visits by outside companies shall require a written order to be issued by our service department.
- The equipment in question shall be sent to our service department by the Ordering Party and at its expense.
- Electrical assembly and installation work, including in the event of service or replacement, shall be carried out at the Customer's expense and shall not be borne by the manufacturer.

Complaints in respect of our products shall be reported to the specialist trader responsible and shall be exclusively handled via the latter.

The manufacturers General Terms and Conditions of Business, as amended, shall apply in addition to the foregoing terms and conditions of service.